

CUTTING ROOMS

SECO CORPORATION

NO.1,LANE 10,KUNG YUAN RD.,XINZHUANG DISTRICT,NEW TAIPEI CITY,TAIWAN,R.O.C.

TEL:886-2-29966803 FAX:886-2-22791008

E-MAIL:secocorp@ms53.hinet.net

➤ Cordless Electric Cutter.....	P.1
➤ Minn Cutter.....	P.4
➤ Round Cutter.....	P.5
➤ Mini Knife Sharpener.....	P.11
➤ Scissors Sharpener.....	P.12
➤ Swatch Cutter.....	P.13
➤ Circular Fabric Sample Cutter.....	P.18
➤ Band Knife.....	P.19
➤ Piping Strip Cutting Machine.....	P.20
➤ Straight Knife Cutter.....	P.25
➤ Scissors.....	P.29
➤ Clipper.....	P.47

Cordless Electric Cutter

■ EC-1000-A SET

ELECTERIC SCISSORS ADAPTOR & BASE



Tungsten carbide steel blade
For the maximum durability and cutting performances unparalleled in similar products



Unique blade design with rounded tips for extra safety during operation.
Changeable blade sets(shoe blade available)



High capacity 1300mA lithium battery with over 450 discharge cycles.
Last up to 100 minutes per full-charge.



Can work either with cord or with cordless.
Maximun working time around 100 minutes while working with cordless.
No time limited while working with cord.

Product Specifications

Color : Black
Body overall size: 27x3.5x4.0cm
Body material: ABS
Blade material: tungsten carbide steel
Duration of charging:8hrs
Voltage:110V~220V
Battery capacity:3.6V/1300mA
Body Weight: 210g
Base Weight: 455g

Dealer _____

The trademark and artworks are the intellectual properly which is preserved by
GREAT KNIVES MANUFACTURE Co., Ltd. All offense against
the copyright will be sued by the owner.

Cordless Electric Cutter

- EC-10 / EC-1
- CORDLESS
ELECTRIC
SCISSORS**



Cordless Electric Cutter

■ MB-60

PORTABLE CORDLESS
ELECTRIC SHEAR(60MM
ROUND KNIFE CUTTER)



■ MB-60X

CORDLESS CUTTERS



MINI CUTTER (50 mm Hexagonal Blade)

■ AS-100K

CLOTH MINI CUTTER
(Standard)



■ AS-100LH

MINI CUTTER WITH LONG HAND
(LONG ARM)



ROUND CUTTER

■ MB-110

ROUND CUTTER

110mm 4-SIDED
SEMI-ROUN BLADE



ROUND CUTTER

■ MB-100

ROUND CUTTER

100mm

8 OCTAGON



ROUND CUTTER

■ MB-90C

ROUND CUTTER

90mm 6-SIDED
BLADE



ROUND CUTTER

■ MB-90

ROUND CUTTER

90mm ROUND BLADE



ROUND CUTTER

■ RC280 220V

ROUND KNIFE CUTTER

Free-movement Thick Material
Round Knife Cutter.



CLOTH MARKING DRILL

■ SM-201L-220V

CLOTH MARKING DRILL WITH HEATE

Tapered Drill with machine:

1.6mm * 2 pcs 2.0 mm * 2 pcs

Features :

(1)The same type of machine can drill the maximum thickness of the model



MINI KNIFE SHARPENER

■ SKS-1



■ SKS-4



SCISSORS SHARPENER

■ RSS-106



■ A1



■ DS-FS

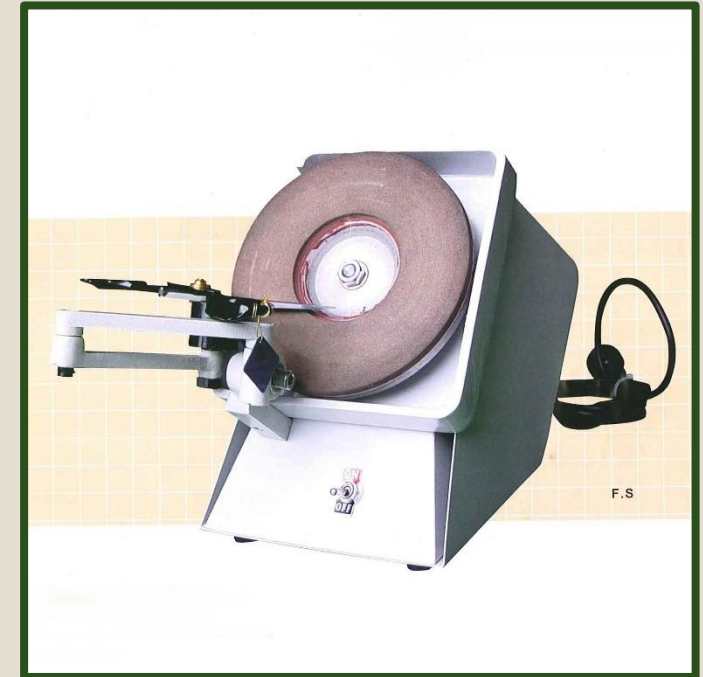

ITEM NO:E.Z.2



■ Features :

- ① *the lightest swatch cutter in the world .(6 kgs only).*
- ② *Bearing drive circular blade .*
- ③ *Installation in 3 minutes on any table top .*
- ④ *Laser alignment cutting .*
- ⑤ *Right angle rail for parallel swatch cutting .*
- ⑥ *Scale cutting mat for speedy measurement.*

Swatch Cutter

INSTALLATION

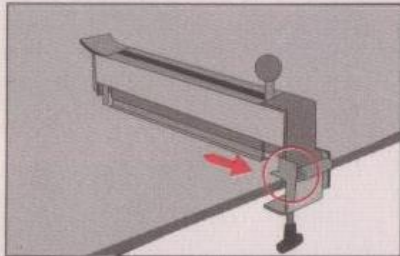

1. CLEAN THE TABLE TOP AND ASSURE THE TABLE TOP IS VERY FLAT.
2. FASTEN C CLAMP.

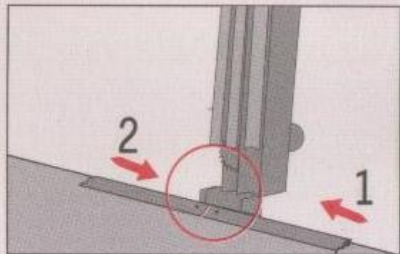

3. INSERT RULER ALIGNING CENTER MARKS AND FASTEN SCREWS.

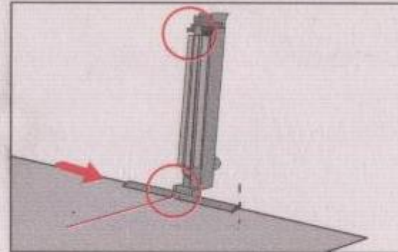

4. SWITCH ON LASER AND CHECK. IF LASER BEAM IS EXACTLY ON THE CENTER MARK.

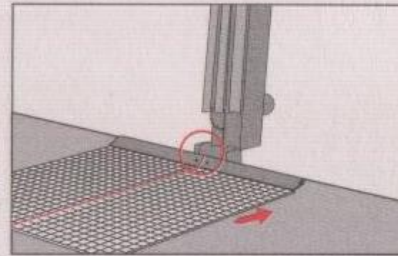

5. PUT CUTTING MAT NEXT TO THE RULER.

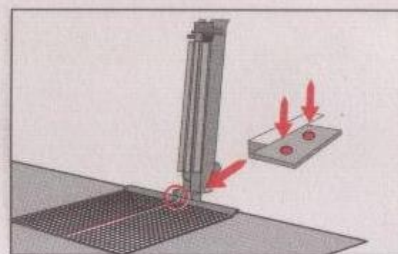

6. TO MAKE SURE THE WHOLE LASER BEAM IS EXACTLY ALIGNED WITH THE LINE ON THE CUTTING MAT.

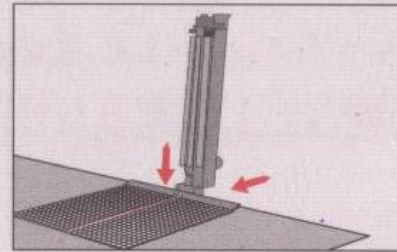

7. IF NOT, LOOSE SCREW OF RULER HOLDER AND MAKE FINE TUNING UNTIL LASER BEAM COMPLETELY ALIGN WITH LINE ON THE MAT.

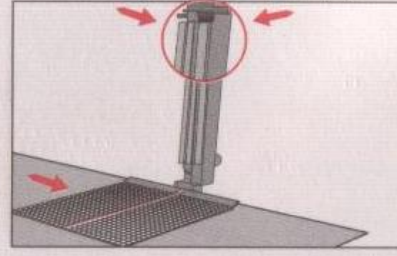

8. CUTTING DEPTH CAN BE ADJUSTED BY LOOSING THE NUTS ON TWO HEIGHT ADJUSTING POLES AND ADJUST THESE TWO POLES UPPER AND LOWER BY A 12mm WRENCH PARALLELY AND FASTEN THE NUTS AGAIN.

UNLESS IT IS NECESSARY FOR SPECIAL FABRIC, A LIGHTER DEPTH OF CUTTING IS RECOMMENDED.

IF FAIL TO CUT THOROUGHLY AFTER DEPTH ADJUSTMENT, IT MAY BE CAUSED BY A POOR QUALITY OF UNEVEN TABLE TOP.

SIMPLY INSERT 2 OR 3 PIECES OF PAPER (SAME SIZE AS LINE CUTTING MAT) UNDER THE CUTTING MAT, THIS PROBLEM CAN BE IMPROVED EFFECTIVELY.

Specifications :

- ① Cutting blade : dia 80mm circular blade(pitch 5mm)
- ② Cutting thickness : 10mm
- ③ Cutting length : 450mm
- ④ Weight : 6 kgs
- ⑤ Scale cutting mat : 500*500mm (double side usable)

Swatch Cutter

OPERATION

1. PUT FABRIC ON THE CENTER OF CUTTING MAT.

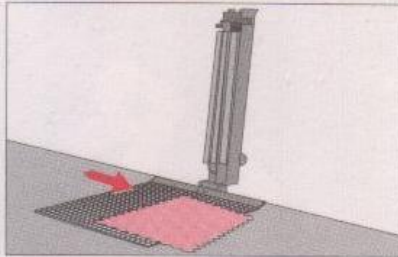

2. AIM THE EDGE TO BE CUT BY LASER BEAM.

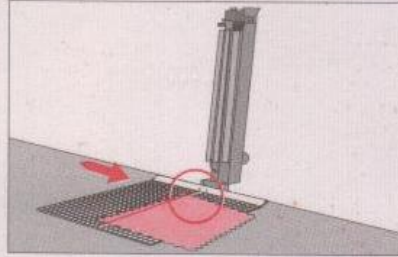

3. PRESS DOWN THE WHOLE CUTTING MECHANISM COMPLETELY BY PRESS HANDLE FIRMLY.

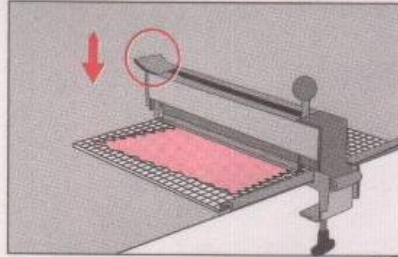

4. SLIDE THE CUTTING HANDLE SMOOTHLY TO CUT.
Please do not cut repeatedly.

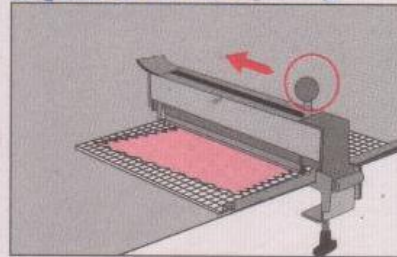

5. SIMPLY MOVE THE CUTTING MAT WITH THE FABRIC LEFT ON IT AND CUT THE OTHER EDGE.

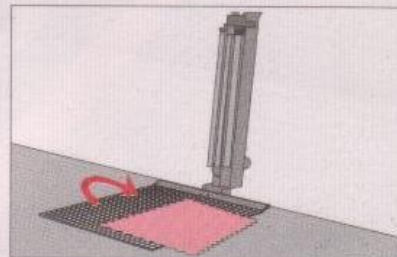

Swatch Cutter

FOR SPECIAL FABRIC

1. INSERT A FILM UNDER THE FABRIC.

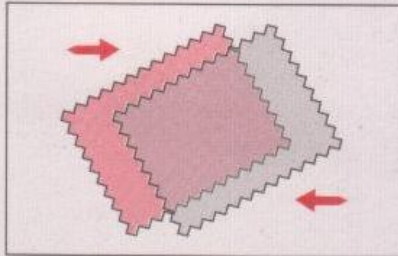

2. CUT AS ABOVE LISTED SEQUENCES.

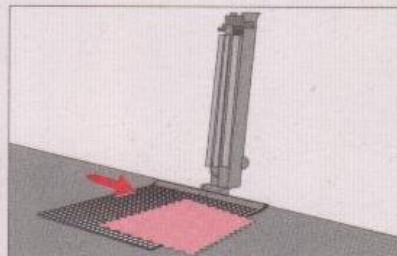

■ Easy to use

- ① Swatch Cutter are easy to install and simple to set-up and use, which apart from the manual adjustment for the depth of the knife, will reduce the need for hands-on setup of the table.

Swatch Cutter

KNIFE REPLACEMENT

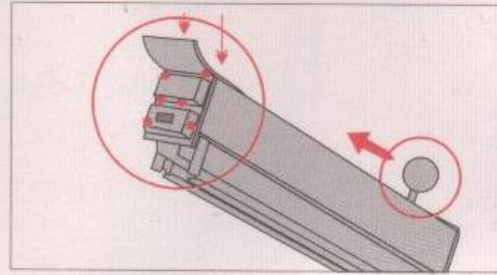

1. REMOVE 8 SCREWS FROM PRESS HANDLE COVER AND SLIDE KNIFE MECHANISM OUT FROM IT'S ORBIT.

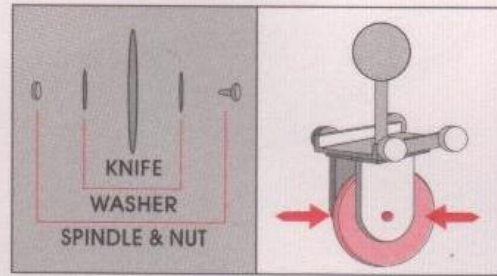

2. LOOSE NUTS AND PULL OUT THE KNIFE SPINDLE AND TAKE THE KNIFE OUT.

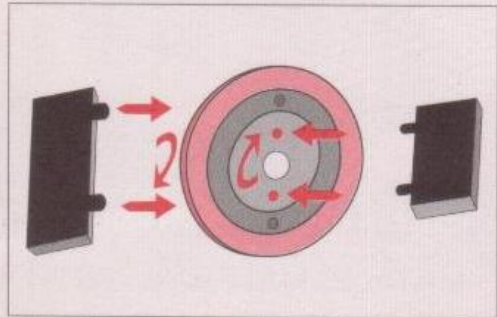

3. LOOSE KNIFE HOLDING CAPS BY TWO SPECIAL TOOLS FROM BOTH SIDES OF KNIFE.

CHANGE A NEW KNIFE AND COVER TWO HOLDING CAPS BACK WITH SAME TOOLS.

PUT CAP COVERED KNIFE BACK TO BRACKET, INSERT SPINDLE AND FASTEN NUTS TIGHTLY.

■ Saves time and money whilst improving quality

- ① Eliminates the cost and time you spend cutting cloth patterns and greatly reduces the time taken to hand cut sample and graded cloth patterns.
- ② Consistent accuracy throughout, any modifications to the pattern can be re-cut quickly and efficiently.
- ③ Reduces your lead times for samples, short production runs and overall pattern development time for both sampling and production

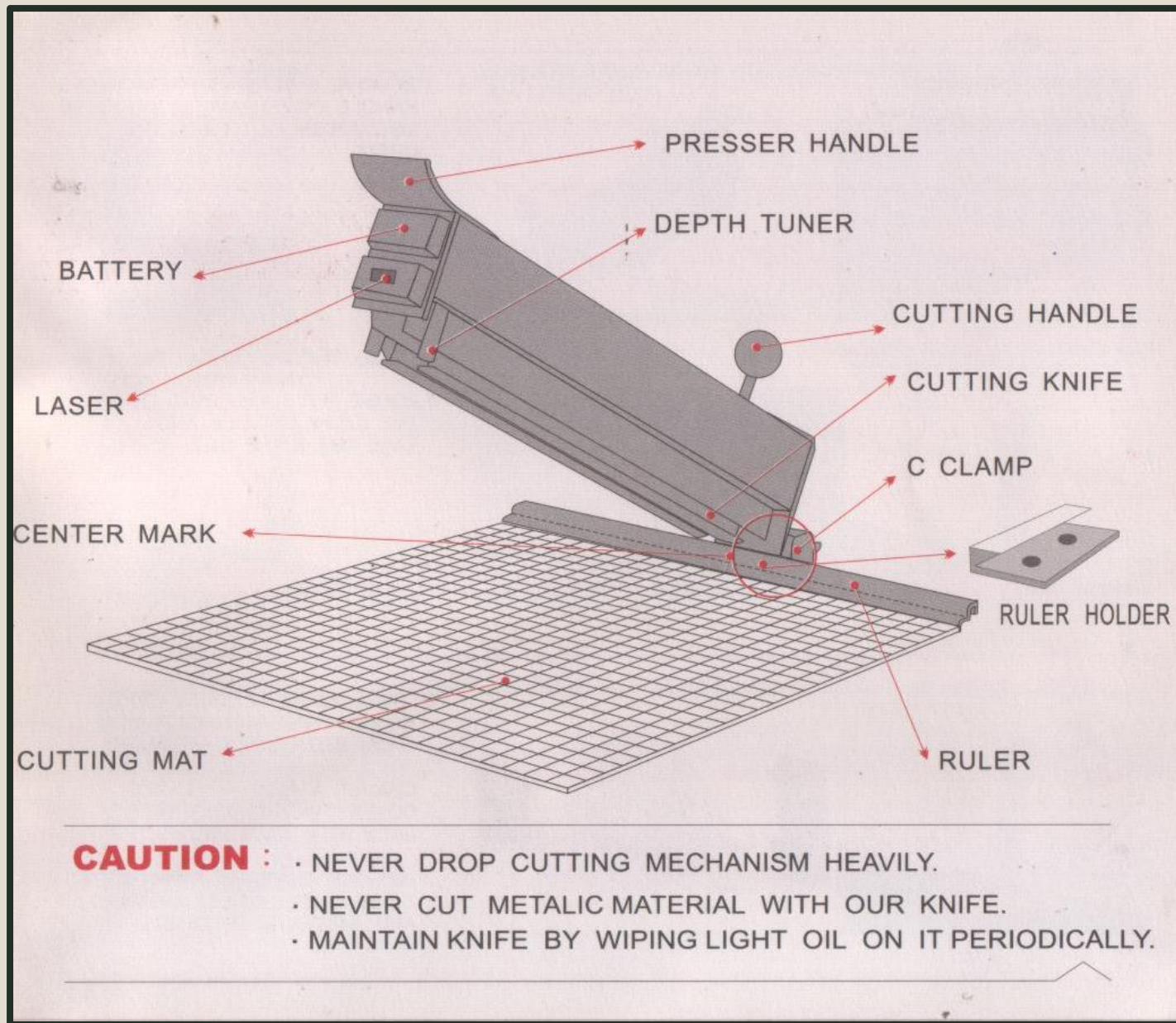

■ Packaging Specification:

2sets/1carton

93*32*34cm

N.W.: 17KG

G.W.: 19KG

2 Scale cutting mat/1carton

52*52*4cm

N.W.: 4.5KG

G.W.: 5KG

CIRCULAR FABRIC SAMPLE CUTTER

■ JZ-72580



■ TS-913



■ GT-C75



BAND KNIFE



DS 2200X10X0.45
DS 2310X10X0.45
DS 2450X10X0.45
DS 2800X10X0.45
DS 3000X10X0.45
DS 3100X10X0.45
DS 3150X10X0.45
DS 3240X10X0.45
DS 3250X10X0.45
DS 3380X10X0.45
DS 3500X10X0.45
DS 3600X10X0.45
DS 3700X10X0.45
DS 3760X10X0.45
DS 3850X10X0.45

DS 3860X10X0.45
DS 3900X10X0.45
DS 3960X10X0.45
DS 4000X10X0.45
DS 4100X10X0.45
DS 4120X10X0.45
DS 4200X10X0.45
DS 4290X10X0.45
DS 4500X10X0.45
DS 4555X10X0.45
DS 4745X10X0.45
DS 4920X10X0.45
DS 5030X10X0.45
DS 5300X10X0.45

PIPING STRIP CUTTING MACHINE

■ LU-922



- Semi-auto piping strip cutting machine
Manual cutting controlled by pedal.
Table, stand, clutch motor and belt
are provided **by customer.**

PIPING STRIP CUTTING MACHINE

■ LU-933



■ New auto speed change piping strip cutting machine

LU-933 is a professional machine that can **quickly trim at 45°** and **prevent strip deformation** based on LU-911B technology in the world.

In addition, the improvement of blade and speed is suitable for **90% of fabrics**: Lycra, Knitwear, Weave, Denim, Shirts and leather, widely applying for clothing, shoes and hat factories. Machine head is light, easy to move, simply installation, quickly switch to manual or auto type to control the speed and tension.

PIPING STRIP CUTTING MACHINE

■ LU-966



■ New auto speed change piping strip cutting machine

LU-933 is a professional machine that can **quickly trim at 45°** and **prevent strip deformation** based on LU-911B technology in the world.

In addition, the improvement of blade and speed is suitable for **90% of fabrics**: Lycra, Knitwear, Weave, Denim, Shirts and leather, widely applying for clothing, shoes and hat factories. Machine head is light, easy to move, simply installation, quickly switch to manual or auto type to control the speed and tension.

The front of aluminum board can be adjusted narrow then suitable for many sizes, types fabric for cutting.

PIPING STRIP CUTTING MACHINE

■ TK



■ AUTO TAPE BINDING CUTTING DEVICE

Install without any damage or drilling holes in interlock machine.

Removed and installed by **two screws**.

No extra purchase DD servo motor, clutch motor is available.

No thread left after cutting.

Extra purchase L2 auto fabric strip cutting machine.

Cutting length can be adjustable according to rotational stitches.

PIPING STRIP CUTTING MACHINE

■ TK-L2



■ AUTO FABRIC STRIP CUTTING DEVICE

Strength TK functions.

Auto tape cutting according to **stitches**.

It's **adjustable** and length setting by stitches from **1-9999**.

STRAIGHT KNIFE CUTTER

■ MA-150U-5

① SIZE : 5"

■ MA-150U-6

① SIZE : 6"

 www.secocorp.com.tw
MA-150U



SPECIFICATIONS :	
Models	MA-150U
Blade Size	5" , 6"
Cutting Capacity	3 1/2" (85 mm) , 4 1/2" (110 mm)
Rated Power	0.25HP (200W)
Rated Voltages	1PHASE 100V , 110/120V , 220/240V 3PHASE 220V , 380V , 415V(400/440)
Single Speed	2Poles 2850RPM or 3450RPM
Standard Blades	High Speed Steel
Optional Blades	Carbon Steel, Teflon Coated, Wave Edge
Available	All Machines Fitted Hss Blade
Belts Available	Fine, Medium, Coarse,
Function	Automatic Abrasive Belt Sharpener, Automatic Safety foot always down when sharpener is released. Automatic oil Lubrication & Sharpening device, Fan guards & starting cover for safety.
Weight	10.00 / 12.5 KGS
Stroke	1" (25 mm)
Special Order	MA-150 DS , Dual Speed Models

STRAIGHT KNIFE CUTTER

- MA-200U-8

- ① SIZE : 8"

- MA-200U-9

- ① SIZE : 9"

- MA-200U-10

- ① SIZE : 10"



STRAIGHT KNIFE CUTTER

■ SES-812 220V

① SIZE : 8"



STRAIGHT KNIFE CUTTER

■ SL-123 10”

① SIZE : 10”

■ SL-123 8”

① SIZE : 8”



SCISSORS

- KI-TC-489 (9")
- **PINKING SCISSORS**
- TRIANGLE TEETH
- HIGH QUALITY STAINLESS STEEL BLADE
- ABS HANDLE
- TEETH:
 - 3mm
 - 5mm
 - 7mm



SCISSORS

- KI-TC-489R (9")
- **PINKING SCISSORS**
- SEMICIRCLE TEETH
- HIGH QUALITY STAINLESS STEEL BLADE
- ABS HANDLE
- TEETH:
 - 3mm
 - 5mm
 - 7mm



SCISSORS

- KI-TC-489A (9")
- PINKING SCISSORS
- TRIANGLE TEETH
- ALL METAL
- TEETH:
 - 3mm
 - 5mm
 - 7mm





SCISSORS

■ TC-230

PINKING SHEAR
230MM



■ TC-240S

TAILOR SHEAR
STAINLESS 10"



■ TC-P260

PROFESSIONAL
TAILOR SHEARS 10"



SCISSORS

■ TC-P300

PROFESSIONAL
TAILOR SHEARS 12"



■ TC-W300H

SCISSORS 12"



■ TC-W300HB

SCISSORS 12"
black plated

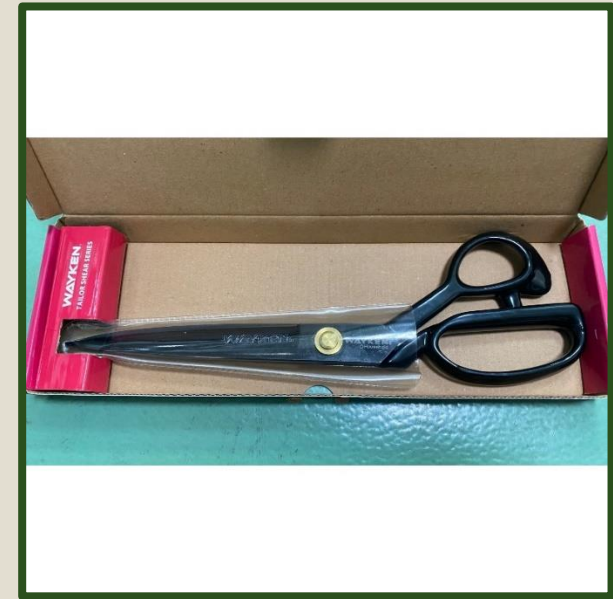

SCISSORS

■ S910

SCISSORS 10"



■ S912

SCISSORS 12"



SCISSORS

■ SE-A62

SMALL SCISSORSS
(PVC BAG)



■ SE-A63

SMALL SCISSORS (ABS+SUS)



SCISSORS

■ 00565

SCISSORS 9-1/2"
SPRING ASSIST
SCISSORS
W/COMFORT GRIP

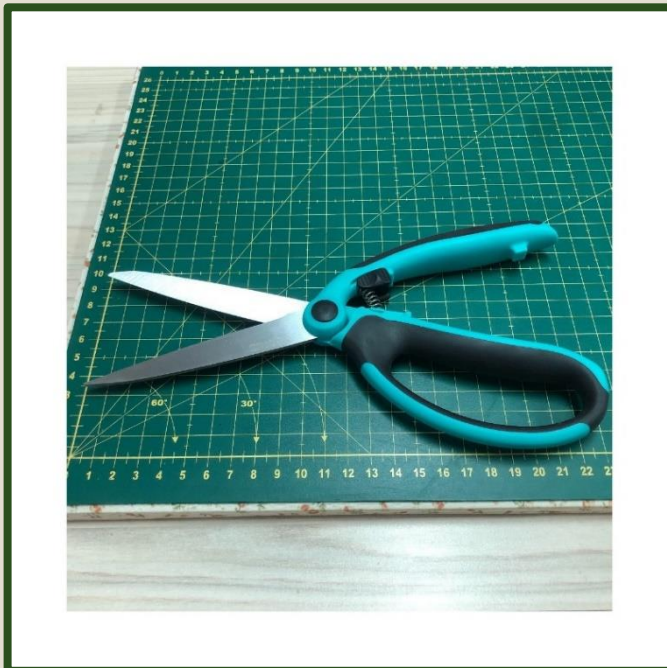

■ SE-L405

EMBROIDERY/NEEDLE
CRAFT SCISSORS
1.5MMX4-1/4"



■ SE-L91105

PROFESSIONAL TAILOR
SCISSORS
3.0MMX10-3/4"



SE-L0085 (8.5")

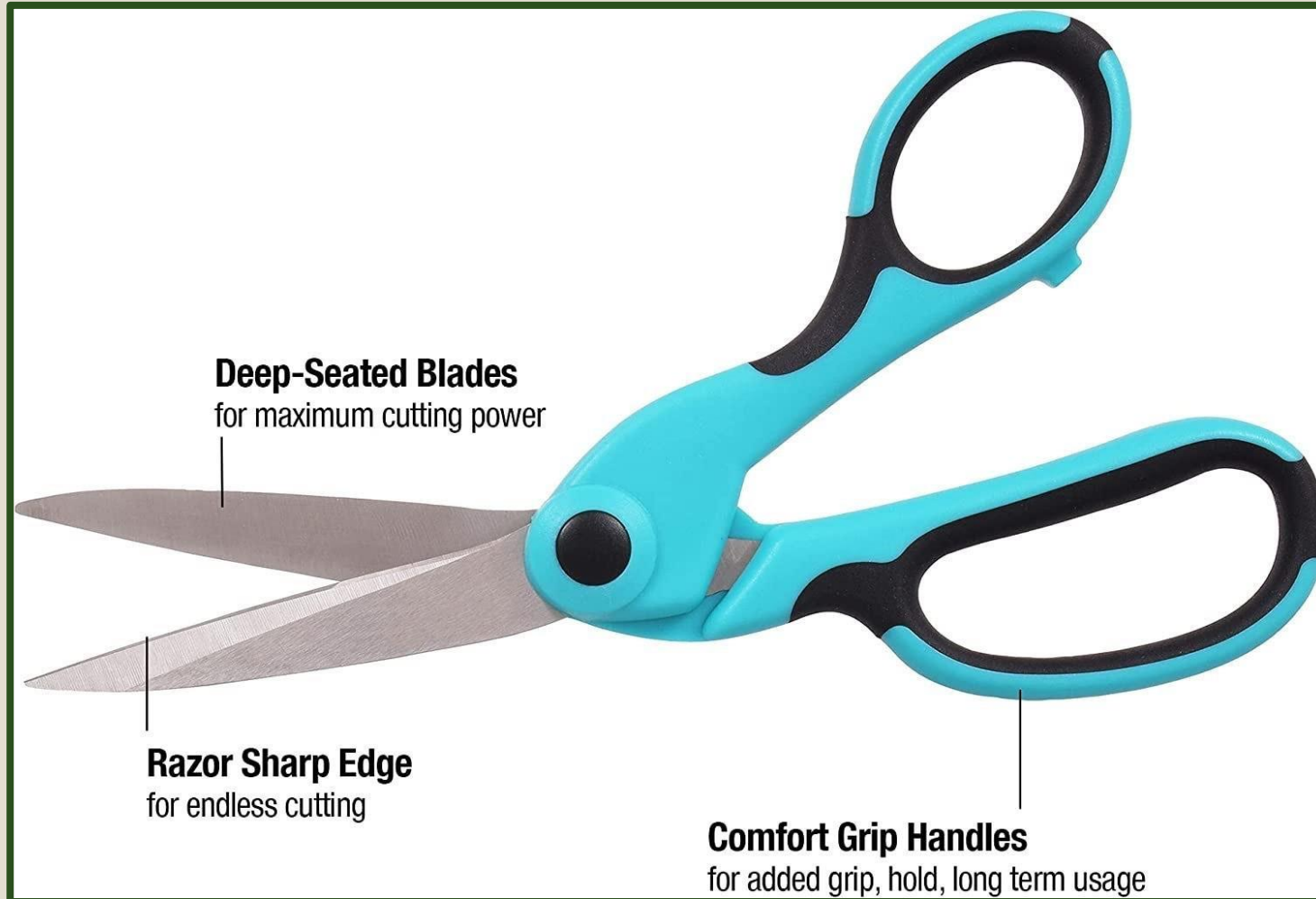

- **8.5" HEAVY DUTY BENT SCISSORS WITH COMFORT GRIP**
- EASILY CUTS
- RAZOR SHARP
- HIGH QUALITY
- PROFESSIONAL GRADE

SE-L0045 (4.5")

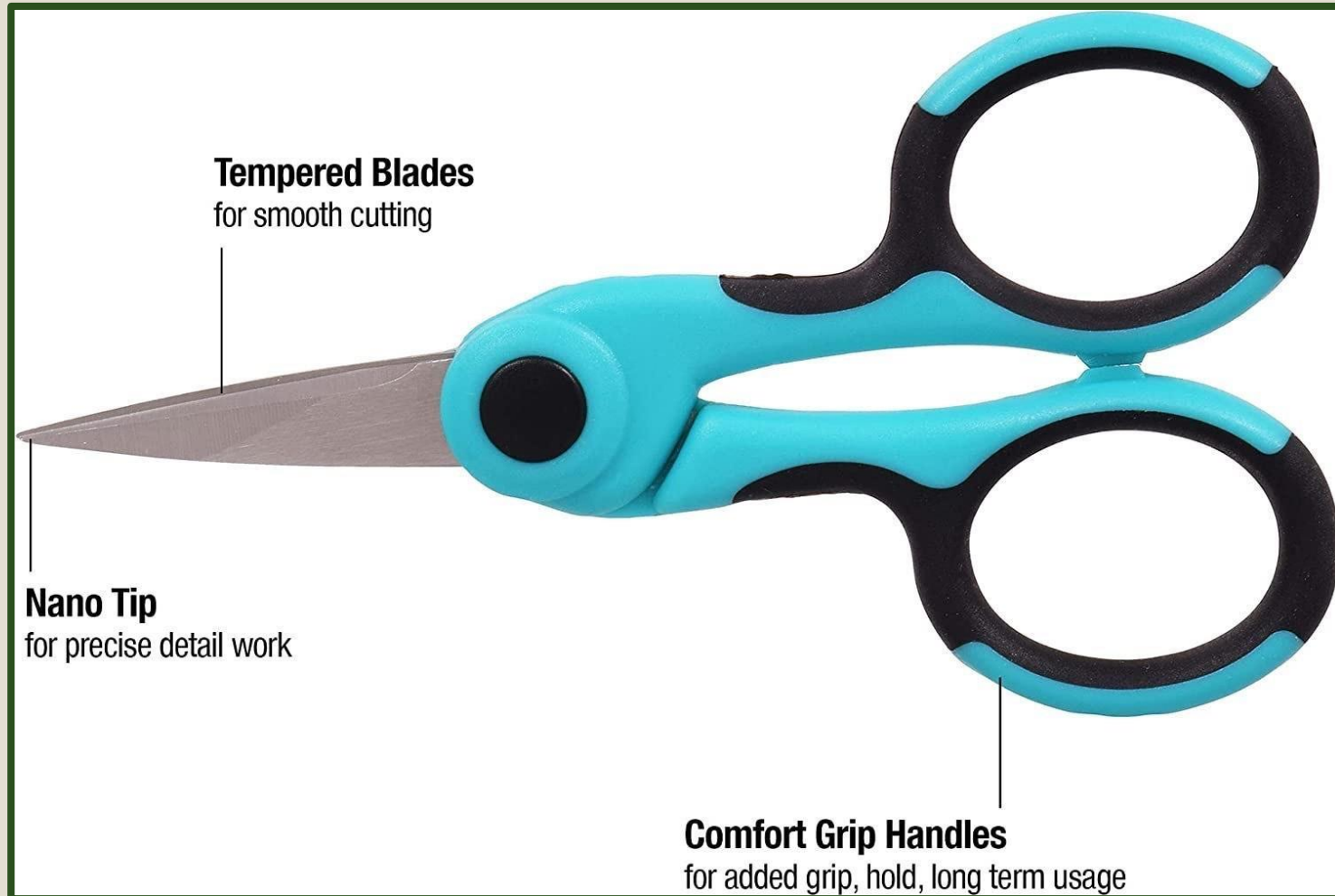

- **4.5" SCISSOR WITH NANO TIP AND COMFORT GRIP**
- EASILY CUTS
- RAZOR SHARP
- HIGH QUALITY
- PROFESSIONAL GRADE

SE-L0050 (5.0")

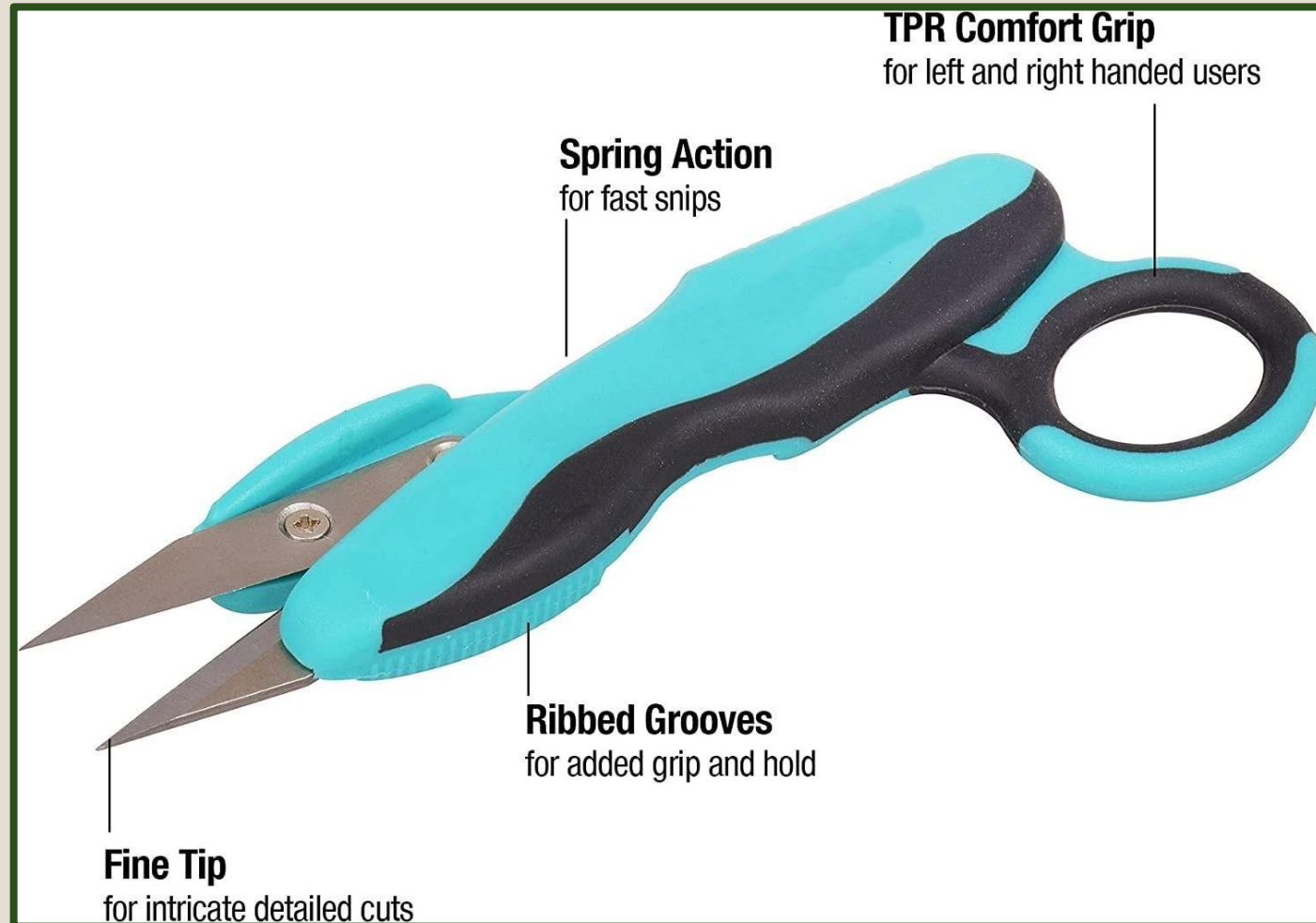

- **5.0" THREAD SNIPS WITH COMFORT GRIP**
- **EASILY CUTS**
- **RAZOR SHARP**
- **HIGH QUALITY**
- **PROFESSIONAL GRADE**

SCISSORS

■ SE-S210

SCISSORS 210MM



■ SE-S211G

SCISSORS 9.5X3.0MM

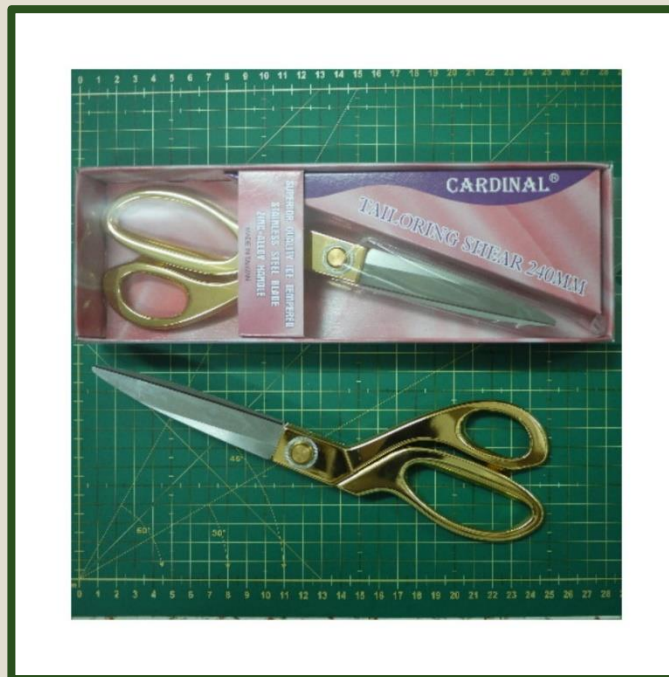

■ SE-S211S

SCISSORS 9.5X3.0MM



SCISSORS

- **SE-S240**
SCISSORS 240MM



- **SE-S240NB** BLACK COLOR
 - **SE-S240NBL** BLUE COLOR
 - **SE-S240NR** RED COLOR
- SCISSORS 9.75"



- **SE-S528A**
SCISSORS



SCISSORS

■ SE-S317-6.25

SCISSORS 6.25"



■ SE-S317-7

SCISSORS 9.5X3.0MM



■ SE-S2785

SCISSORS 8.5X3.0MM



SCISSORS

■ SE-S318-8.5

SCISSORS 8.5"



■ SE-S318-9.5

SCISSORS 9.5"



■ SE-S2795

SCISSORS 9.5X3.0MM



SCISSORS

■ SE-S5887

SCISSORS 8.75X3.0MM



■ SE-S5897

SCISSORS 9.75X3.0MM



■ SE-S807

SCISSORS 7.5X2.5MM



SCISSORS

■ SE-S808

SCISSORS 8.5X2.5MM



■ SE-S1085

SCISSORS 8.5X3.0MM



■ SE-S1095

SCISSORS 9.5X3.0MM



CLIPPER

- KI-TC-789N (4.5")
- CLIPPERS
- YARN CUTTING SCISSORS
- HIGH END STAINLESS STEEL MATERIAL
- HANDWORK BLACKSMITHING
- INTEGRAL MOLDING



KI-TC-789NB (4.5")

- KI-TC-789NB (4.5")
- **CLIPPERS**
- YARN CUTTING SCISSORS
- HIGH END STAINLESS STEEL MATERIAL
- HANDWORK BLACKSMITHING
- INTEGRAL MOLDING



CLIPPER

■ CY-106

CLIPPER 110MM



■ S701-BS

METAL HANDLE THREAD
CLIPPER



■ S703

QUICK CLIP CUTTER



CLIPPER

■ TC100

PLASTIC HANDLE
THREAD CLIPPER



■ TC801

QUICK CLIP CUTTER, ORANGE



TC801B

BLUE



■ TC801G

GREEN



TC801Y

YELLOW



CLIPPER

■ TC805

QUICK CLIP CUTTER



■ TC805B

CLIPPERS



■ TC50

THREAD CUTTER



CLIPPER

■ TC-808SP

SUPER ALLOY THREAD
CLIPPER



■ TC-RGMIX

RING TYPE THREAD
CUTTER (MIXED)



■ SE-A17B

CLIPPER (BLUE)



CLIPPER

■ DW-TC8005

CLIPPER



■ SE-CA013

CLIPPERS WITH LID

